

Blockhaus 40 (575x480)

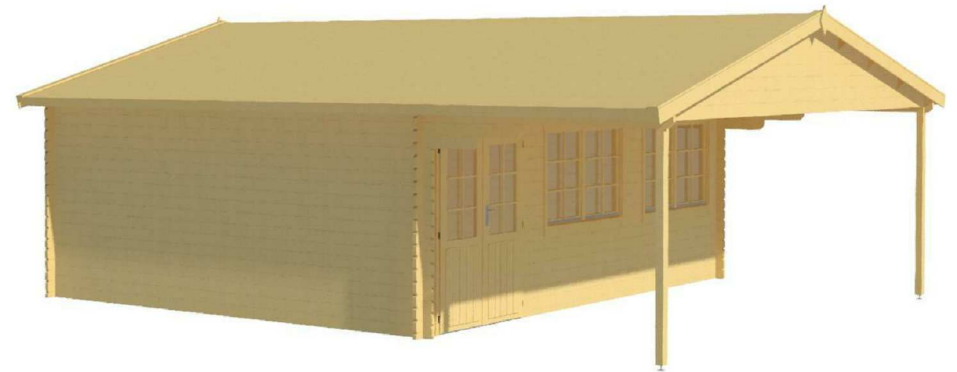

Blockhaus 40 (575x480)

Floor Plan

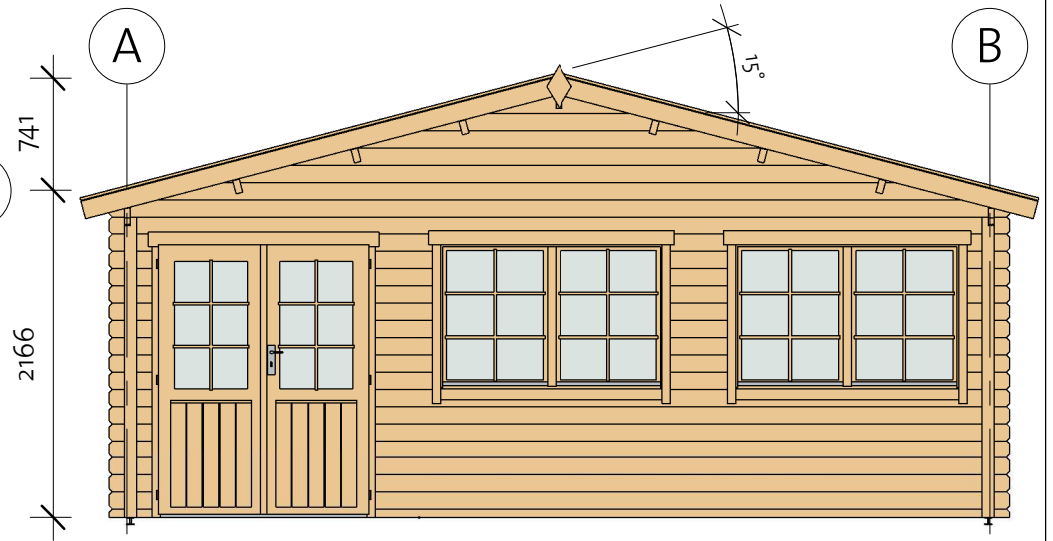
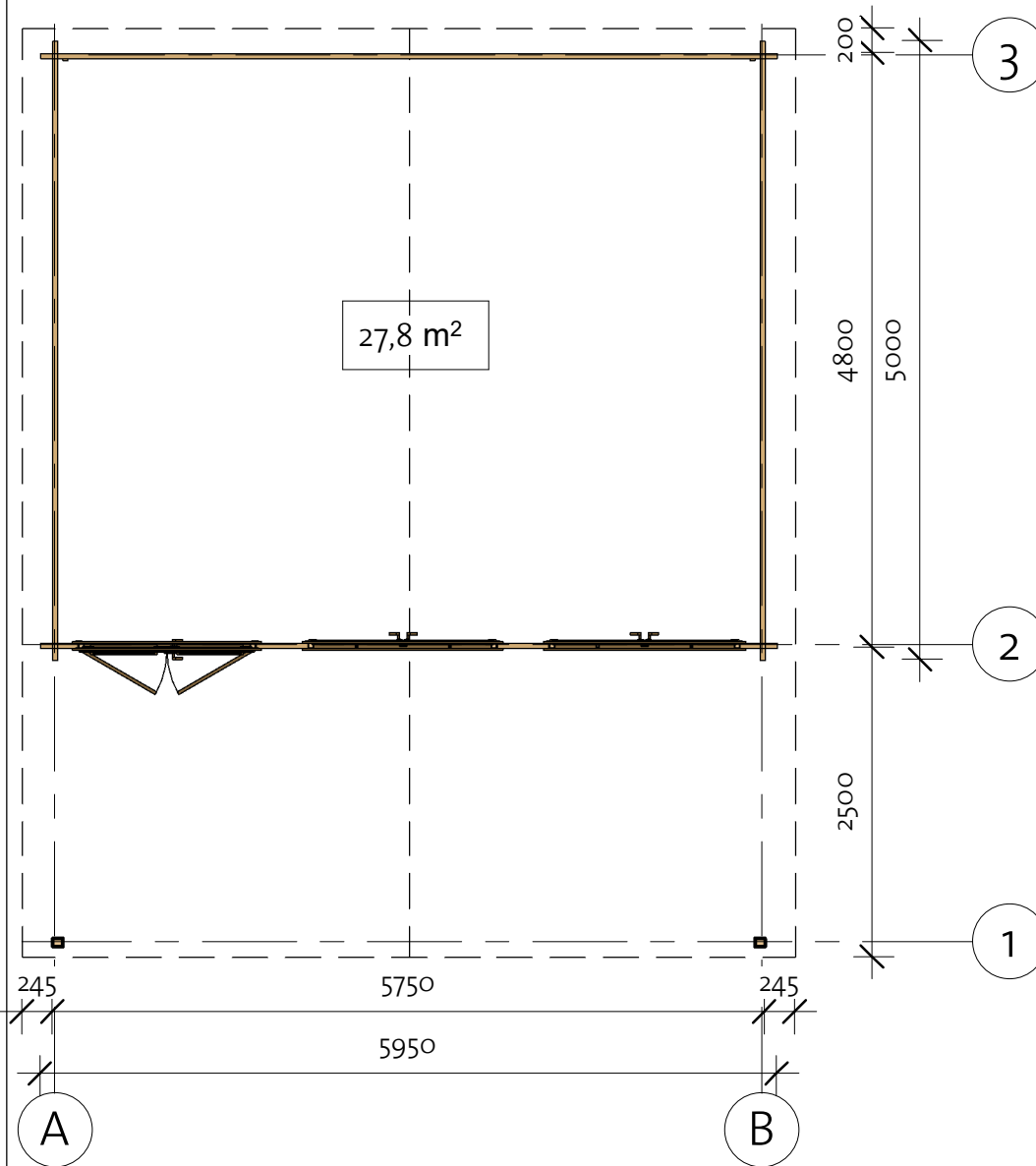
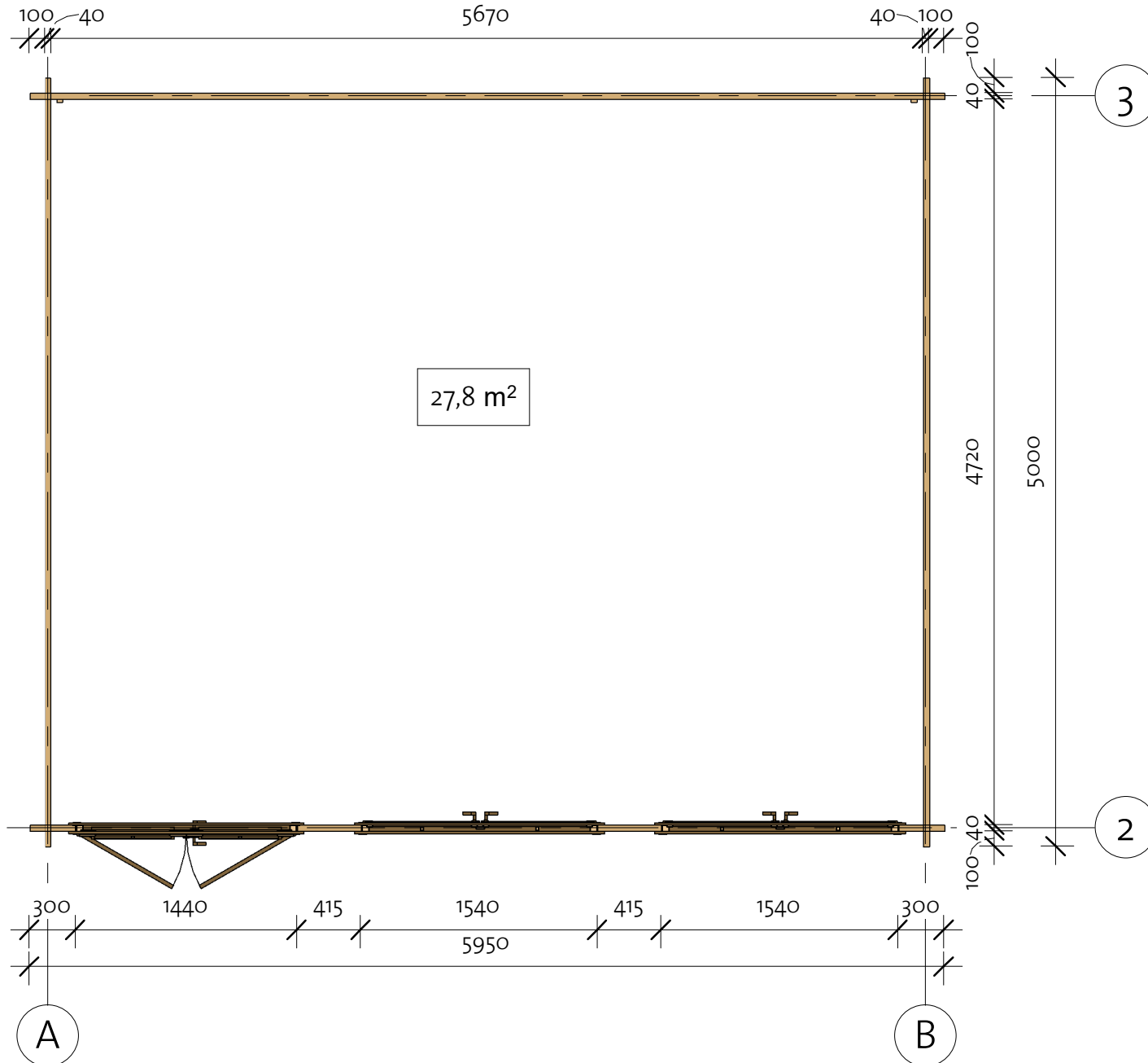

91918111_201209

Blockhaus 40 (575x480)

Wall 1

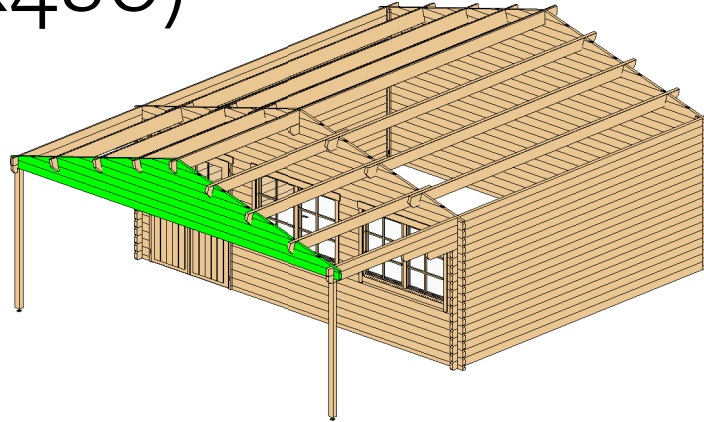

Wall 1			
Mark	Profile	Count	Cut Length

1LG-1 *	40X114	1	876
1LG-2 *	40X114	1	1748
1LG-3 *	40X114	1	2619
1LG-4 *	40X114	1	3491
1LG-5 *	40X114	1	4285
1LG-6 *	40X114	1	5234
1LG-7 *	40X114	1	5950
1LG-8	40X114	1	5950

* Gable - delivered premounted

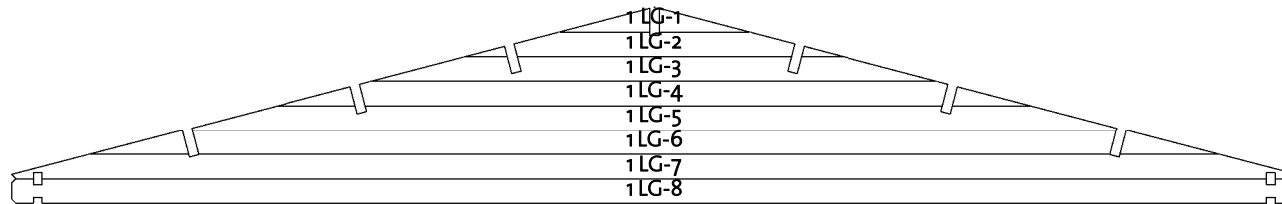

Log Profile Wall 1	
Profile	Profile

40X114	
--------	--

Blockhaus 40 (575x480)

Wall 2

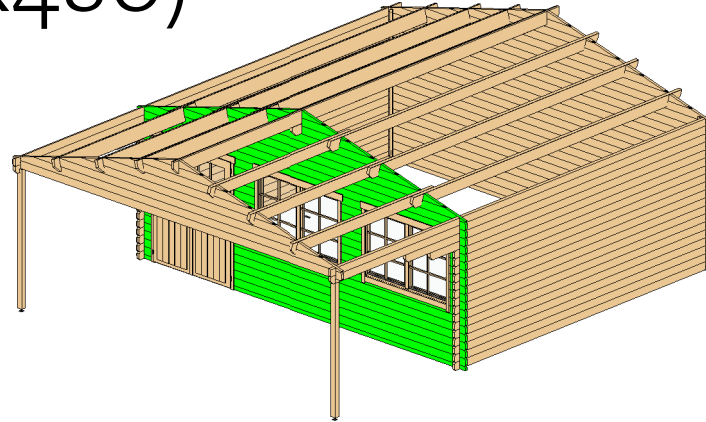

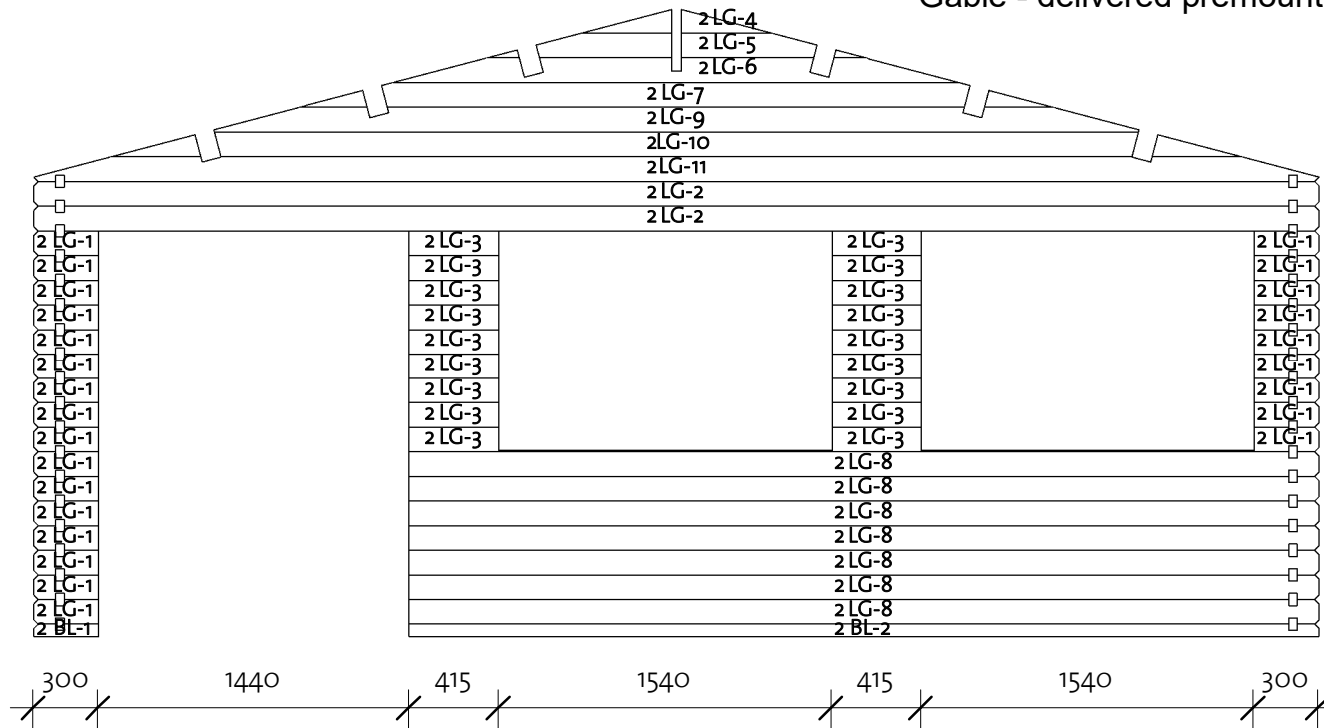

* Gable - delivered premounted



Wall 2			
Mark	Profile	Count	Cut Length

2BL-1	40x57	1	300
2BL-2	40x57	1	4210
2LG-1	40x114	25	300
2LG-2	40x114	2	5950
2LG-3	40x114	18	415
2LG-4 *	40x114	1	876
2LG-5 *	40x114	1	1748
2LG-6 *	40x114	1	2619
2LG-7 *	40x114	1	3491
2LG-8	40x114	7	4210
2LG-9 *	40x114	1	4285
2LG-10 *	40x114	1	5234
2LG-11 *	40x114	1	5950

Log Profile Wall 2	
Profile	Profile

40x57	
40x114	

Blockhaus 40 (575x480)

Wall 3

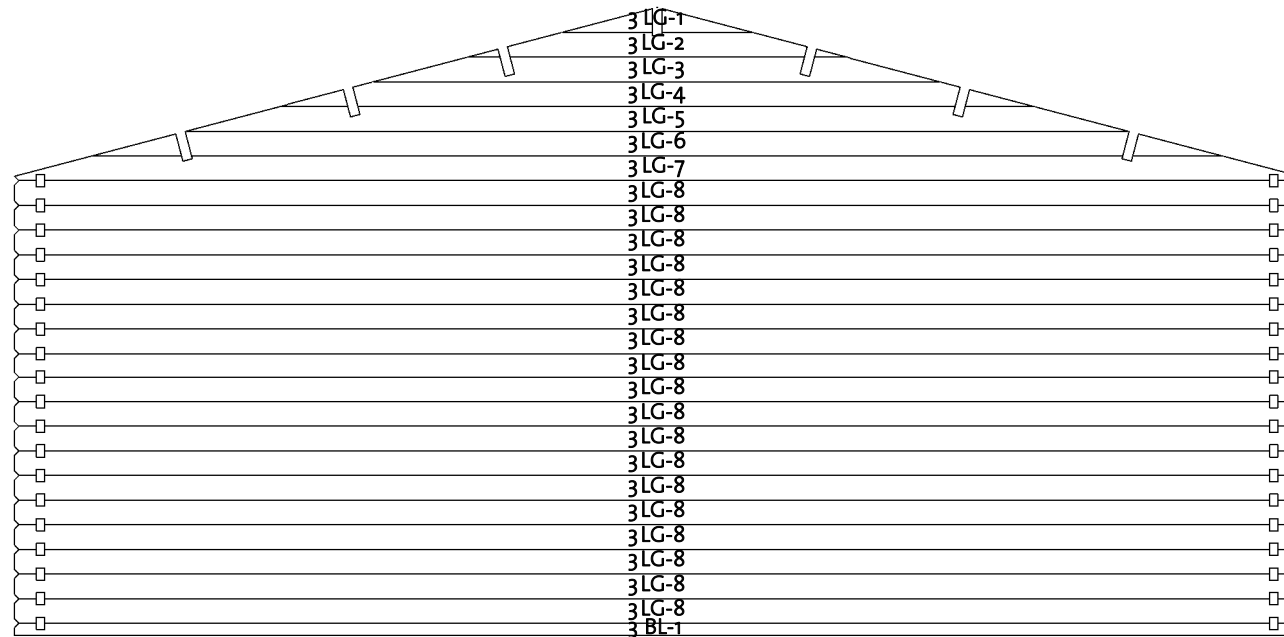
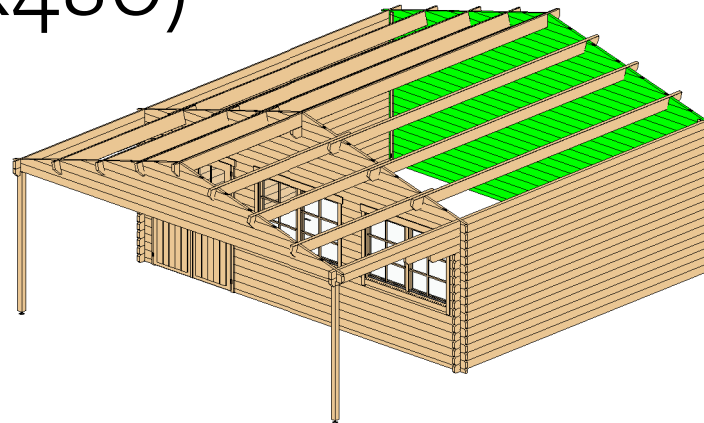



Wall 3			
Mark	Profile	Count	Cut Length

3BL-1	40x57	1	5950
3LG-1*	40x114	1	876
3LG-2*	40x114	1	1748
3LG-3*	40x114	1	2619
3LG-4*	40x114	1	3491
3LG-5*	40x114	1	4363
3LG-6*	40x114	1	5234
3LG-7*	40x114	1	5950
3LG-8	40x114	18	5950

* Gable - delivered premounted

Log Profile Wall 3	
Profile	Profile

40x57	
40x114	

Blockhaus 40 (575x480)

Wall A

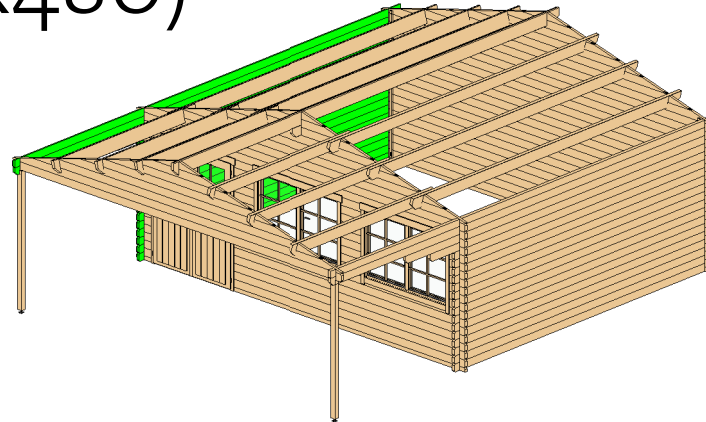

Wall A

Mark	Profile	Count	Cut Length
------	---------	-------	------------

ALG-1	40X114	15	5000
ALG-2	40X114	1	5475
ALG-3	40X114	1	5950
ALG-4	40X114	1	4880
ALG-5	40X114	1	2520
ATL-1	40X114	1	4980
ATL-2	40X114	1	2520

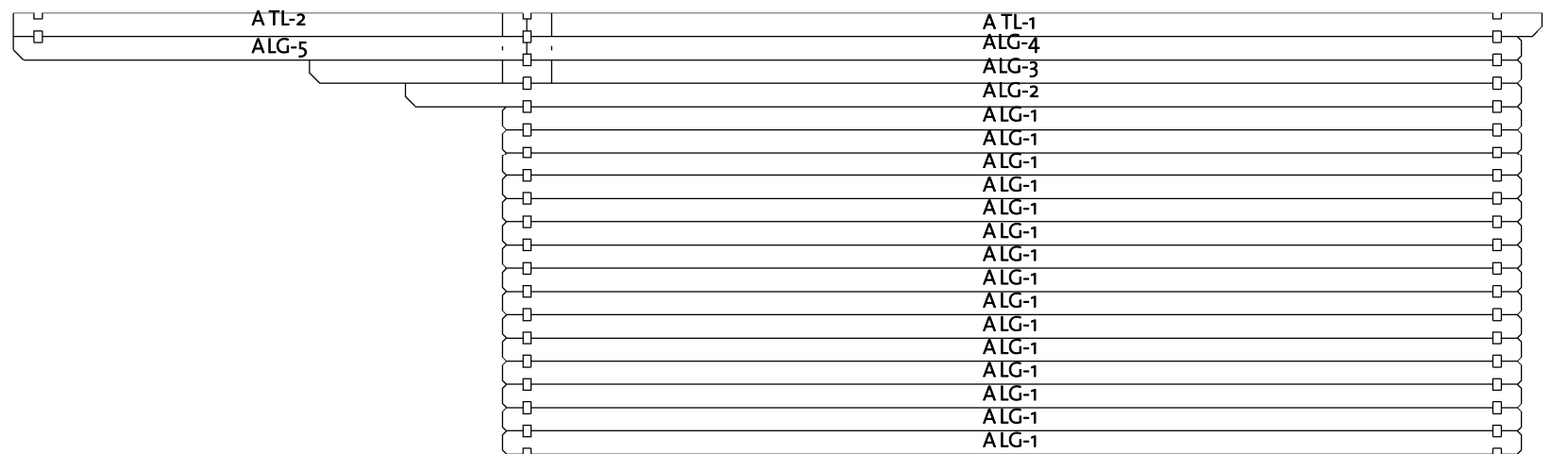

Log Profile Wall A

Profile	Profile
---------	---------

40X114

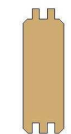

40X114

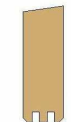

Blockhaus 40 (575x480)

Wall B

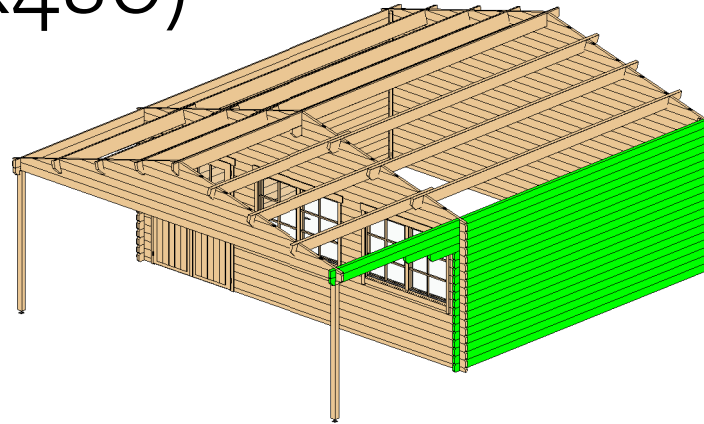

Wall B			
Mark	Profile	Count	Cut Length

BLG-1	40X114	15	5000
BLG-2	40X114	1	5475
BLG-3	40X114	1	5950
BLG-4	40X114	1	4880
BLG-5	40X114	1	2520
BTL-1	40X114	1	4980
BTL-2	40X114	1	2520

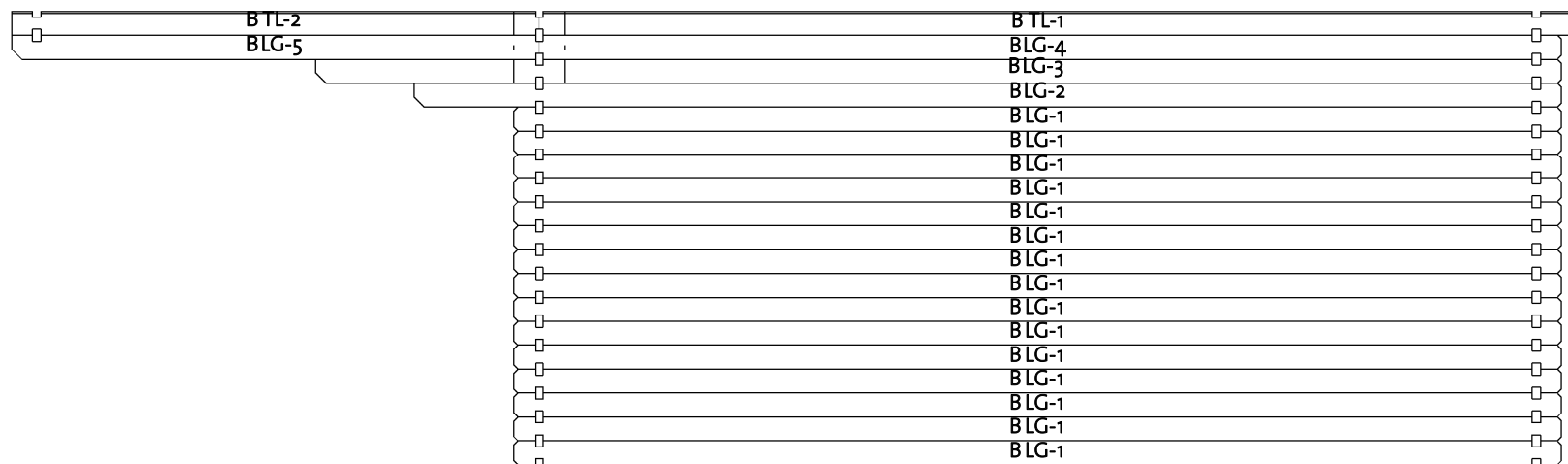

Log Profile Wall B	
Profile	Profile



40X114	
40X114	

Blockhaus 40 (575x480)

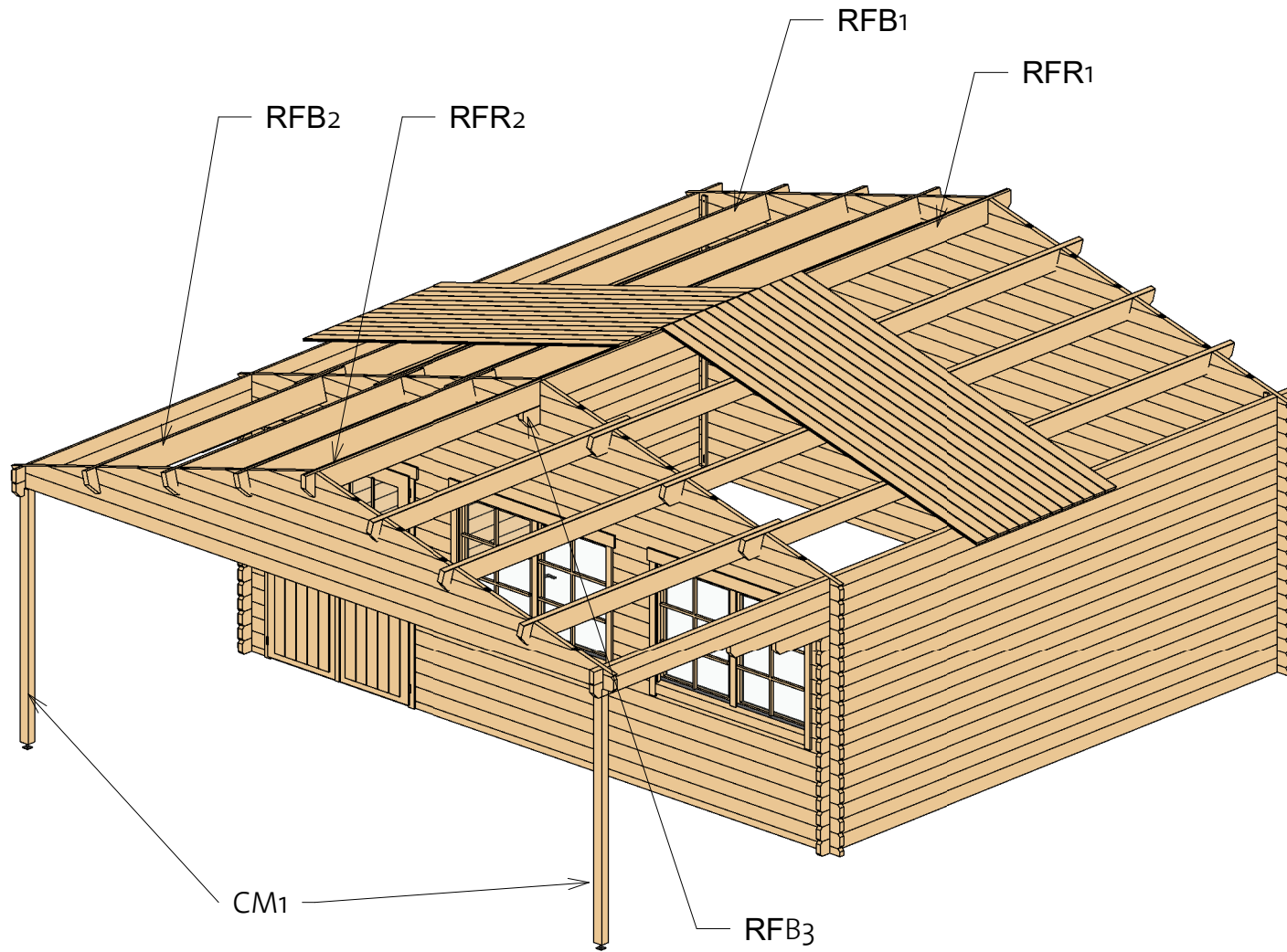
Roof 1



Roof				
Mark	Type	Profile	Count	Length

RB	17x114		134	3220
RFB1	Beam 45x195		6	5200
RFB2	Beam 45x195		6	2740
RFB3	Beam 45x143		1	400
RFR1	Ridge 45x195		1	4980
RFR2	Ridge 45x195		1	2520

Column schedule			
Mark	Type	Length	Count

CM1	Post 80x70	1995	2
-----	------------	------	---

Blockhaus 40 (575x480)

Roof 2

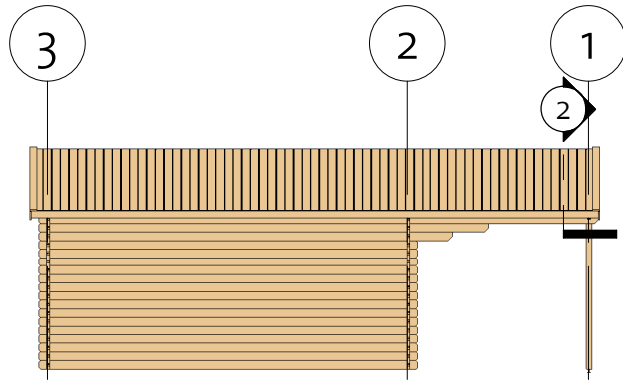

② Facia

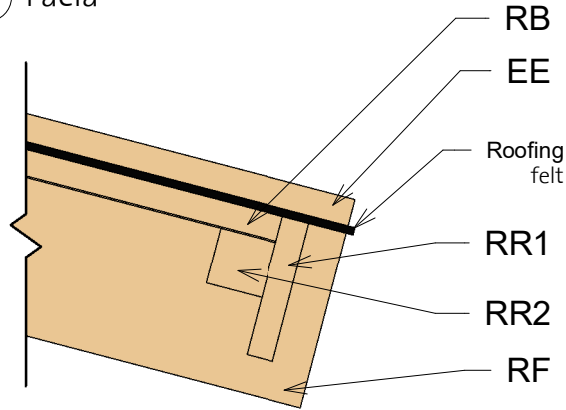

③ Roof Reinforcement

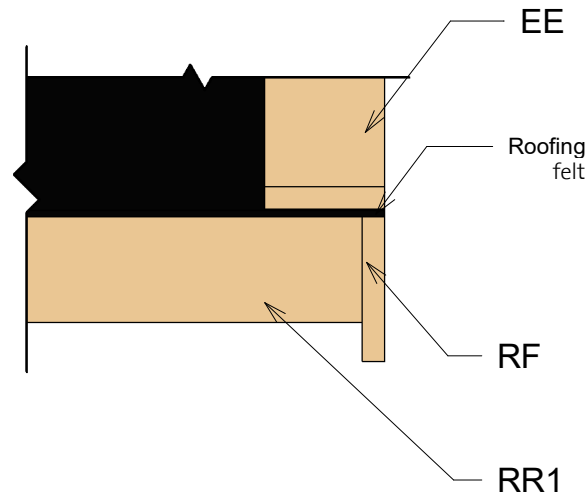
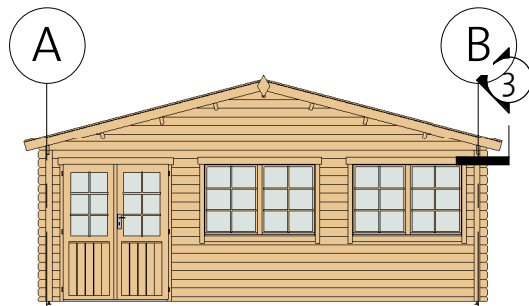

















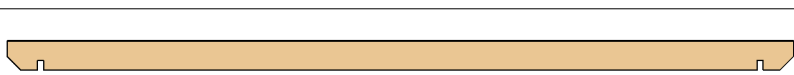



Fascia Schedule

Mark	Type	Profile	Count	Length
EE	Eave Edging 18x95		4	3269
RF	Roof Fascia 18x120		4	3269
RR1	Roof reinforcement 18x95		4	3750
RR2	Roof reinforcement 38x38		4	3750



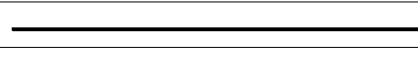









Blockhaus 40 (575x480)

List of all items 1

3	BL-1	Log 40x57		1	5950
2	LG-2	Log 40x114		2	5950
A	LG-3	Log 40x114		1	5950
B	LG-3	Log 40x114		1	5950
1	LG-8	Log 40x114		1	5950
3	LG-8	Log 40x114		18	5950
A	LG-2	Log 40x114		1	5475
B	LG-2	Log 40x114		1	5475
	RFB1	Beam 45x195		6	5200
A	LG-1	Log 40x114		15	5000
B	LG-1			15	5000
	RFR1	Ridge 45x195		1	4980
A	TL-1	Log 40x114		1	4980
B	TL-1	Log 40x114		1	4980
A	LG-4	Log 40x114		1	4880
B	LG-4	Log 40x114		1	4880
2	BL-2	Log 40x57		1	4210
2	LG-8	Log 40x114		7	4210
	RB	17x114		134	3220
	RFB2	Beam 45x195		6	2740
Windboard 18x40				4	2200
CM1	Post 80x70			2	1995

Blockhaus 40 (575x480)

List of all items 2

A	LG-5	Log 40x114		1	2520	
B	LG-5	Log 40x114		1	2520	
	RFR2	Ridge 45x195			1	2520
A	TL-2	Log 40x114			1	2520
B	TL-2	Log 40x114			1	2520
2	LG-3	Log 40x114			18	415
	RFB3	Beam 45x143			1	400
2	BL-1	Log 40x57			1	300
2	LG-1	Log 40x114			25	300

RR1	Roof reinforcement 18x95		4	3750
RR2	Roof reinforcement 38x38		4	3750
EE	Eave Edging 18x95		4	3269
RF	Roof Fascia 18x120		4	3269

CDD12R	Classic double door 12 right	1425	1835	1
--------	---------------------------------	------	------	---

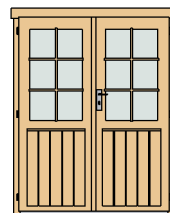





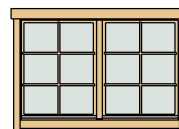

DCB6	Door Crossbar 6	--	--	2
------	--------------------	----	----	---

CDW1	Classic double window 1	1530	990	2
------	----------------------------	------	-----	---



WCB6	Windows Crossbar 6	--	--	4
------	--------------------	----	----	---

Hitblock	300-400 mm		
Dowels	16,0 x 150		8
Bolts	M8 x 70		12
Screws	5,0 x 70		16
Screws	6,0 x 140		40
Screws	4,0 x 40		120
Screws	4,0 x 50		760

Romb	2
------	---



Adjustable post foot	2	45
-------------------------	---	----



g1918111_201209

Blockhaus 40 (575x480)

List of all items 3

① Gable 1

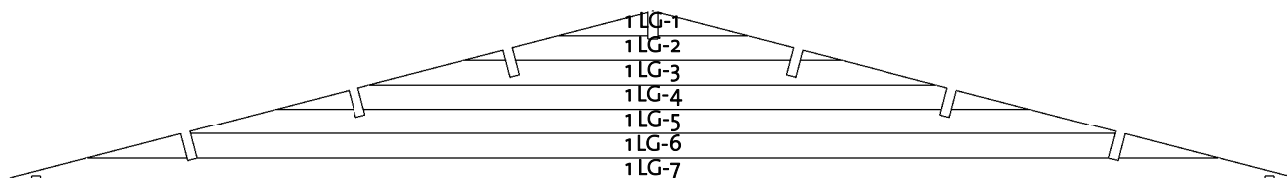

② Gable 2

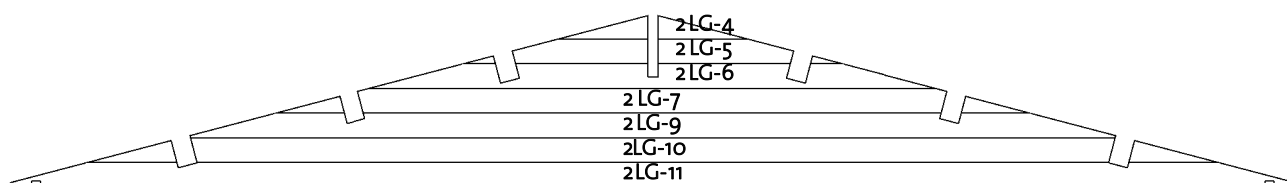

③ Gable 3

